

- To see details of specifications and operations, refer to the instruction manual:  YF05 instruction manual

Component identification

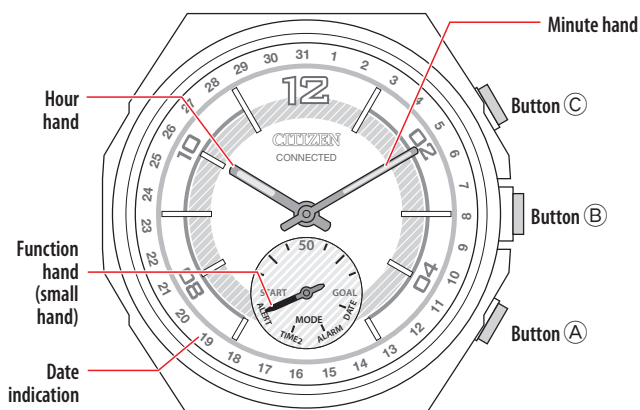

- Actual appearance may differ from the illustrations.

Before connecting with a smartphone

You must install the dedicated app “CITIZEN CONNECTED” on your smartphone. After installing it, start it, make an account and execute pairing between the phone and the watch to connect them.

The flow of connection is as follows.

- This watch communicates with smartphones through Bluetooth Low Energy power-saving communication technology.
- The Bluetooth® word mark and logos are registered trademarks owned by Bluetooth SIG, Inc.
- Google, Wear OS by Google, Google Play and Google Play logo, Google Fit, Google Assistant, Google Calendar, Gmail, Android and Android Go Edition, Android One, Google Pixel, Google Nest Thermostat are trademarks of Google LLC.
- IOS is a trademark or registered trademark of Cisco Systems, Inc. or its affiliates in the United States and other countries, and is used under license.

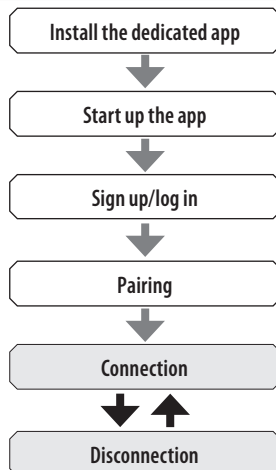

Requirements for connection

Android	Android OS 7.0 -
iPhone	iOS 15.0 -
Bluetooth	Bluetooth smart/4.2 Low Energy

- You cannot install the dedicated app when your smartphone is not compatible with it.
- Fulfillment of the requirements of your smartphone does not warrant normal operation of the app.
- Update of the dedicated app may be stopped after manufacturing of the watch is ended.

Actual screens and/or indication of the dedicated app may differ from those on this manual depending on your usage conditions and/or changes of specifications at update of the app.

In that case, follow instructions on the actual screen of the app.

Execute pairing with the smartphone

Execute pairing at first when connecting the watch and your smartphone.

- Unique pairing information is saved on the watch and smartphone as pairing is executed.
- Make an account at the startup of the dedicated app. An e-mail address which can be used for e-mail reception is required for making an account.
- Keep the mail address and password for the account in case they are required.

Executing pairing

- For pairing, you have to operate both the watch and the smartphone.
- Charge the smartphone sufficiently beforehand.
- Turn on Bluetooth and function(s) related with location information on your smartphone.

1. Download the dedicated app “CITIZEN CONNECTED” at an app site and install it.



2. Start the dedicated app.

- Keep the app screen displayed until pairing is finished.

3. Tap [HYBRID].

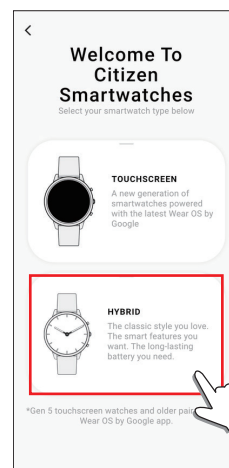

4. Make an account.

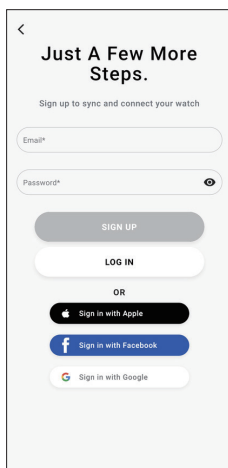

Just A Few More Steps.

Sign up to sync and connect your watch

Email*

Password*

SIGN UP

LOG IN

OR

Sign in with Apple

Sign in with Facebook

Sign in with Google

- Proceed to authentication process when you made an account. An authentication number will be sent to the mail address you entered here.
- Tap [LOG IN] if you had logged out without executing pairing after making an account before.
- Once signed up, the status (login status) is kept regardless whether the app is activated or deactivated.

5. Press the right middle button (B) and tap [CONTINUE] on the screen of the app as the [Start Pairing] screen is shown.

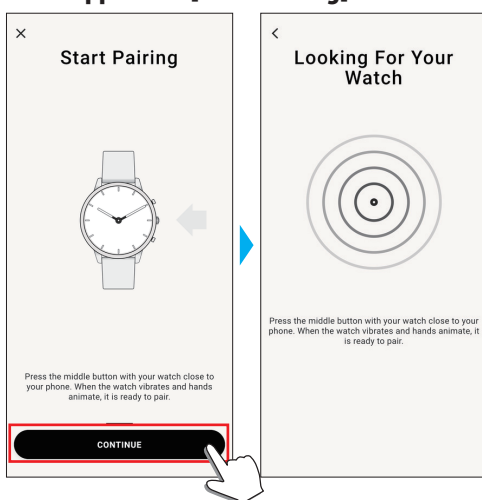

6. Tap [THIS IS MY WATCH].

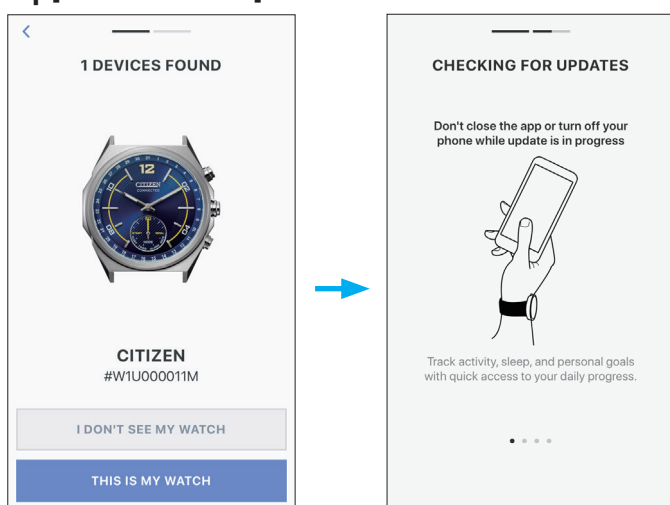

- The watch displayed on the screen may look different from the actual one you use.
- Tap [I DON'T SEE MY WATCH] when not only its color but whole appearance looks different from yours.
- When update of the watch has started, wait until it is finished.

7. Within the time limit, press and hold the upper right button (C) on the watch.



Pairing starts.

To start pairing on the screen of the app

Tap the watch icon (C) on the upper right of the home screen, swipe left on the [CHOOSE DEVICE] screen and tap [ADD NEW WATCH].

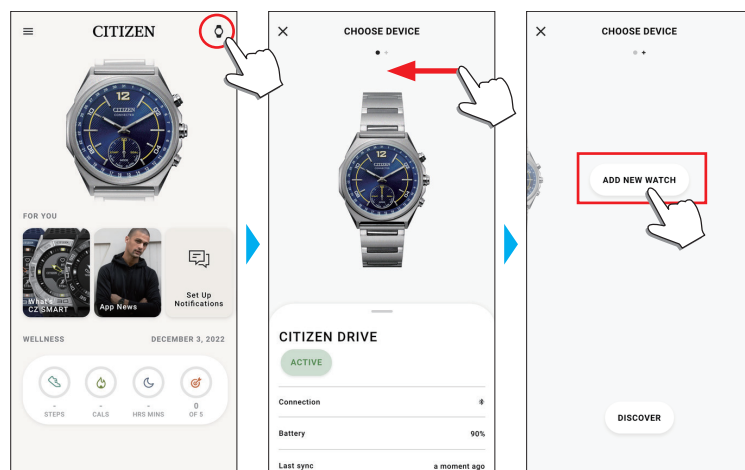

When pairing fails

When pairing fails and the target watch does not appear on the dedicated app, try pairing again following the steps below.

1. Remove "Citizen Connected HR" on Bluetooth® setting of your smartphone.
2. Turn off the Bluetooth function on your smartphone and turn it on again.
3. Execute pairing between the watch and the smartphone again.



When connection fails after pairing (cancelling pairing)

Try pairing again following the steps below.

1. Tap the watch icon (🕒) on the upper right of the home screen.
2. Swipe left or right on the [CHOOSE DEVICE] screen to display the watch with which you want to connect your smartphone.
3. Swipe up the bottom tab on the [CHOOSE DEVICE] screen to display the menu.

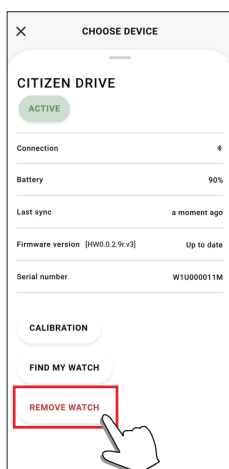

4. Tap [REMOVE WATCH].
5. Remove "Citizen Connected HR" on Bluetooth® setting of your smartphone.
6. Turn off the Bluetooth function on your smartphone and turn it on again.
7. Execute pairing between the watch and the smartphone again.

Synchronizing your watch and smartphone

After pairing, the watch and your smartphone are connected and synchronized automatically as the dedicated app is started up or displayed on the phone.

- All the hands of the watch turn fully around when synchronization starts.
- The time and calendar on the watch are also synchronized with those on the smartphone.
- It may take a certain period of time for data synchronization.
- Some operations of the app such as change of settings are accompanied with data synchronization.
- Synchronization does not start if distance between the smartphone and the watch is 10 m (30 feet) or more or there is any obstacle between them.

Swiping down the home screen also starts data synchronization.

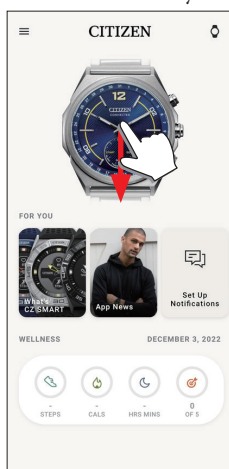

Adjustment of the time and calendar

This watch receives time information from your smartphone at every connection and adjusts the time and calendar automatically.

- You cannot adjust time and calendar on the watch only by itself.

Battery replacement

This watch tells you battery replacement period when battery voltage becomes low by stopping all the hands at the 6 o'clock position.

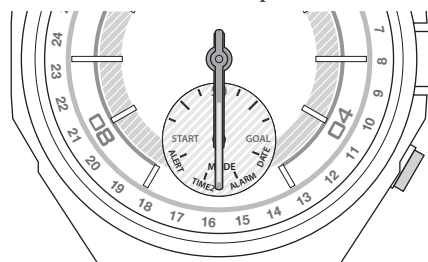

- The indication is canceled by pressing button but early replacement of the battery is recommended.
- You can check battery remaining of the watch on the [PROFILE] screen of the dedicated app.

When replacing the battery

1. Turn the case back of the watch counterclockwise using a coin or something similar.

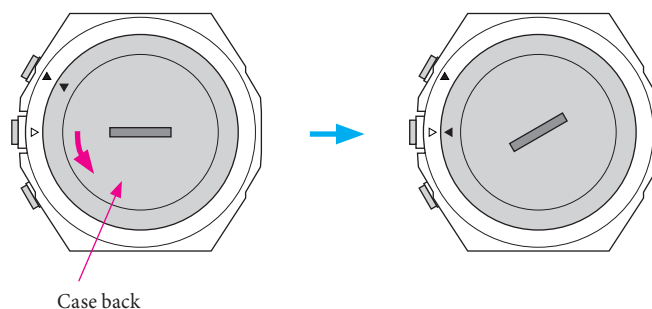

- Turn it so as that the ▲ mark on the case back is aligned with the △ mark on the case.
2. Turn the watch over to remove the battery.
 3. Put a new battery in to the watch.
 4. Confirm that the rubber packing for waterproofing is set at the correct position.

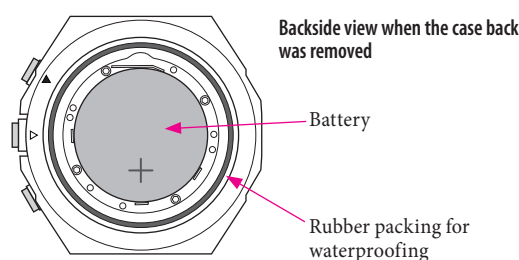

5. Put on the case back aligning its ▲ mark with the ▲ mark on the case and turn it clockwise.

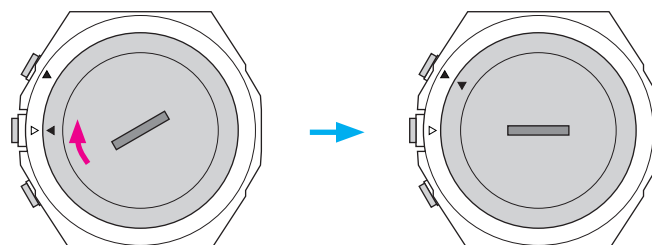

- Turn it so as that the ▲ mark on the case back is aligned with that ▲ on the case.
- Take care so that any foreign matter such as thread waste is not caught between the case back and the case.
- Turn the case back securely until the slot become straightly horizontal.
- After replacing the battery, start the dedicated app and synchronize the watch and the smartphone.